

Data Sheet

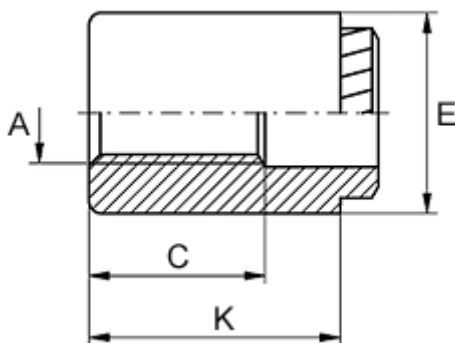

Article number: 12511600050500
Description: KLEE-coil 511 600 050.500
M5 Stainless 1.4305

Measures



Female thread A	= M5
Height K	= 11
Hole diameter +0.1	= 6.8
Min distance to edge	= 4.1
Min material thickness	= 1.5
Outer diameter E	= 9
Thread length	= 9